

MANUAL DE MONTAJE

A3F8



MAMPARA ANGULAR DE DUCHA

1 HOJA CORREDERA + 2 FIJAS

A3F8

1

PRESENTAMOS PERFILES "U" DE FIJOS, EN PAREDES, SEGÚN CORRESPONDA SU POSICIÓN, COLOCANDO EL MAS ALTO AL LATERAL FIJO, NIVELANDOLOS, A 3 MM. DEL BORDE DEL PLATO DE DUCHA Y MARCAMOS TALADROS.

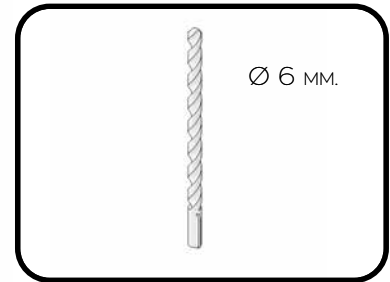
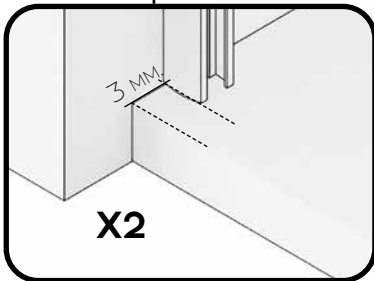

2

TALADRAR LA PARED CON BROCA DE 6MM.



3

ATORNILLAR LOS PERFILES "U" A PARED, FIJANDOLOS CON TACOS DEL N° 6 Y LOS 6 TORNILLOS 4.2X32.



4

COLOCAMOS GOMA DE ESTANQUEIDAD INFERIOR EN LAS HOJAS FIJAS E INTRODUCIMOS LOS VIDRIOS EN LAS "U", APOYANDOLOS SOBRE ESTA.

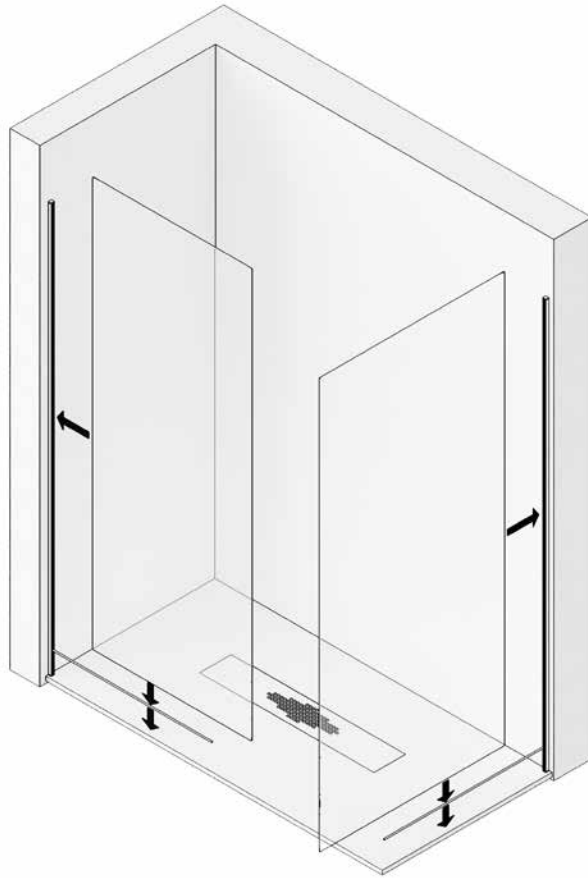

5

COLOCAR LA PINZA GUIA INFERIOR EN EL EXTREMO DEL VIDRIO FIJO FRONTAL, MONTANDOLA PREVIAMENTE SEGÚN CORRESPONDA SU POSICIÓN.



MONTAJE PINZA GUIA INFERIOR

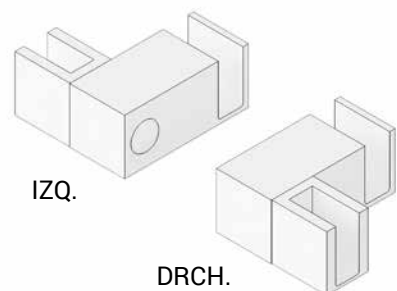
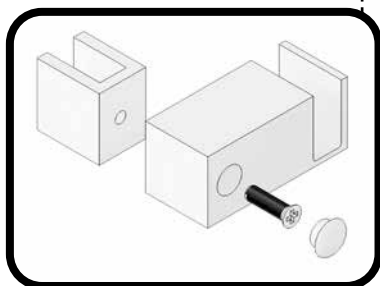

A3F8

6

PRESENTAR GUÍA SUPERIOR
CON VASO A PARED Y VASO
UNIÓN LATERAL FIJO, SOBRE
EL VIDRIO FIJO FRONTAL,
NIVELAR Y MARCAR LOS
TALADROS A PARED.

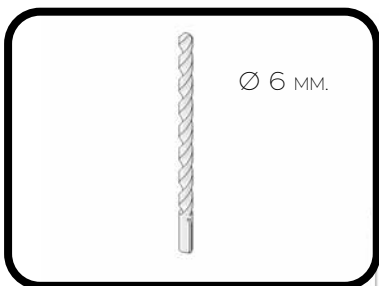
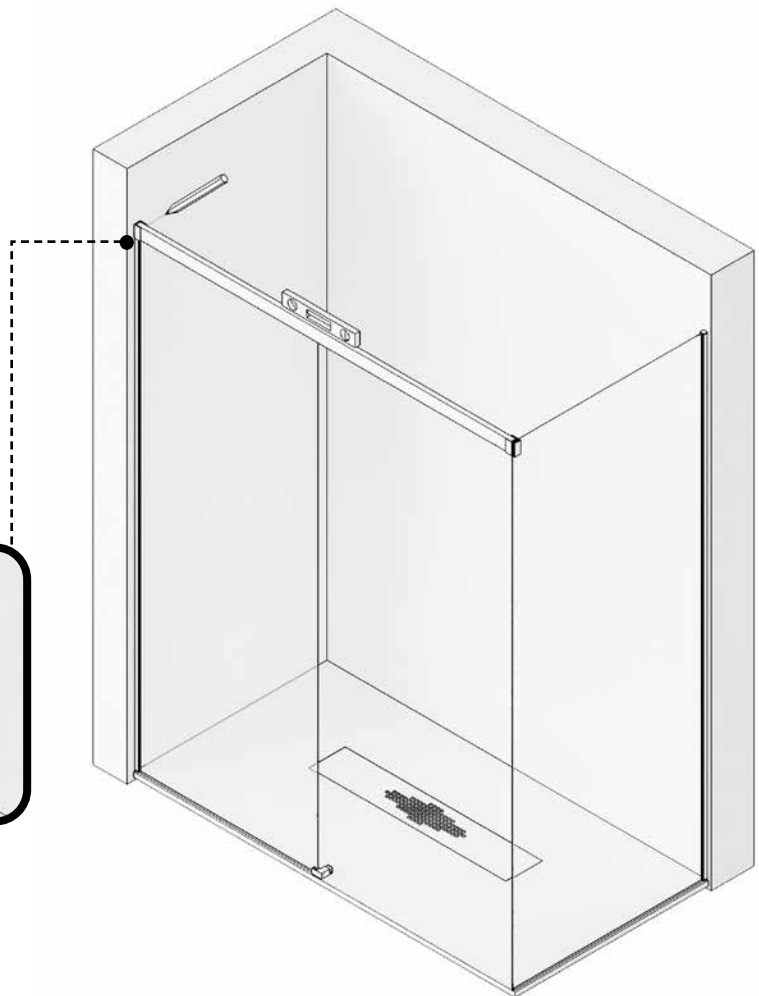
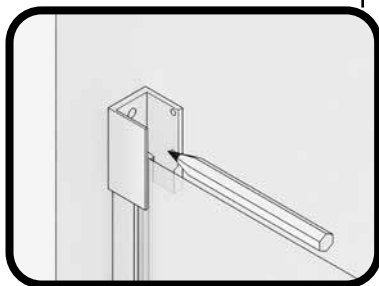

7

TALADRAR LA PARED CON
BROCA DE 6MM.



ETIRAR CRISTALES FIJOS SI FUESE
NECESARIO.

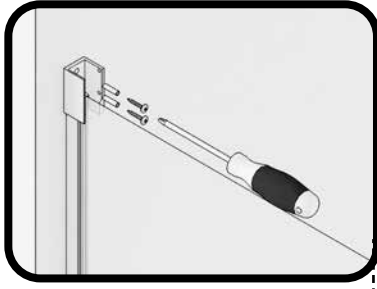

8

ATORNILLAR LOS VASOS SOPORTE GUÍA SUPERIOR A PARED Y LATERAL FIJO.



9

INTRODUCIR LOS TOPES FRENO EN GUIA SUPERIOR, DESPLAZANDO UNO HACIA EL FINAL DE LA HOJA FIJA FRONTAL Y OTRO AL VERTICE, COLOCAR LA GUIA SUPERIOR EN LOS VASOS Y FIJAR LA COGIDA A LA GUIA MEDIANTE LOS TORNILLOS PRISIONEROS CON LLAVE HALLEN. ENGOMAR CRISTALES FIJOS A PERFILES PARED Y A GUÍA SUPERIOR.

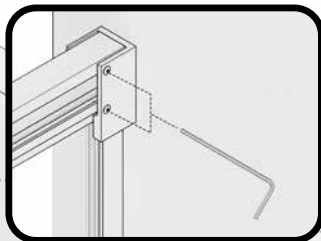
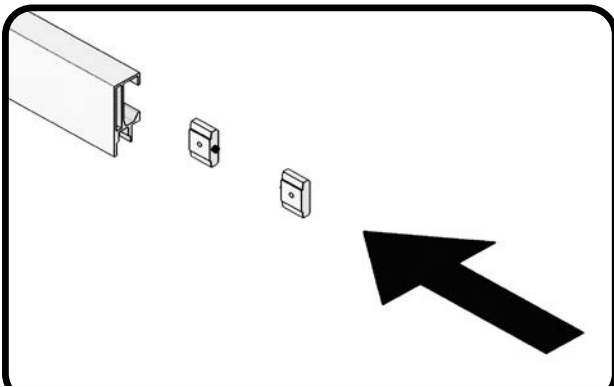

10

MONTAR CONJUNTO RUEDAS, GRADUADAS EN SU ALTURA MÁXIMA Y GOMA INFERIOR VIERTEAGUAS EN HOJA CORREDERA.

ALTURA MÁXIMA

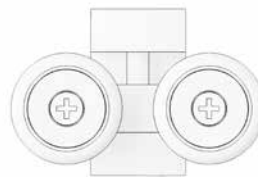

ALTURA MÍNIMA

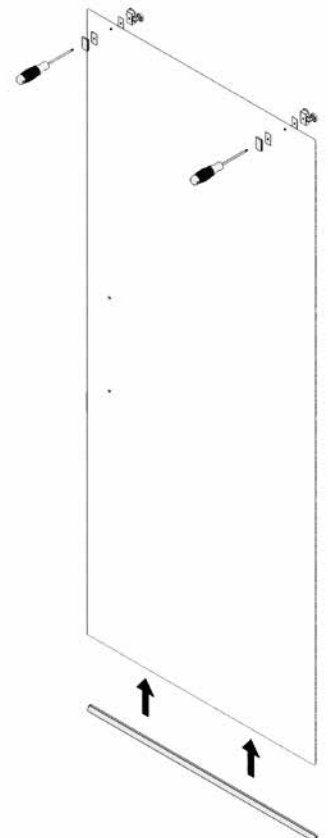
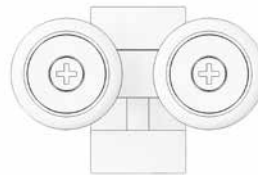

A3F8

11

COLGAR LA HOJA CORREDERA EN LA GUIA SUPERIOR, INTRODUCIENDO EL CONJUNTO RUEDAS EN LA MISMA Y EN LA PINZA GUIA INFERIOR, GRADUANDO EN ALTURA Y NIVELANDO LA HOJA CORREDERA AL CIERRE CON EL LATERAL FIJO, HACIENDO DESCENDER LA HOJA MEDIANTE LOS TORNILLOS DE REGULACION DE RUEDAS, CON UN DESTORNILLADOR.

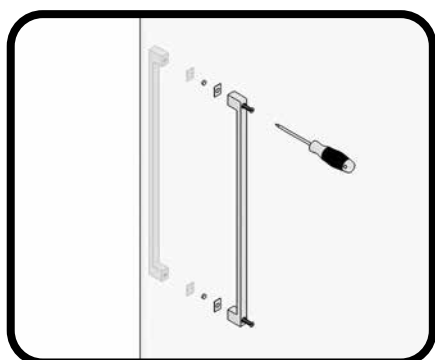
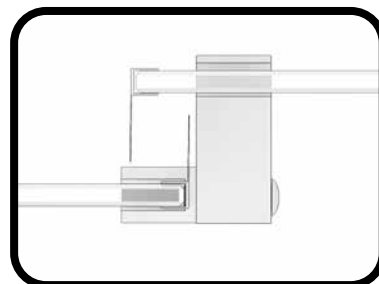
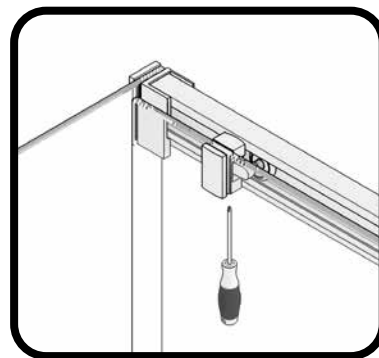
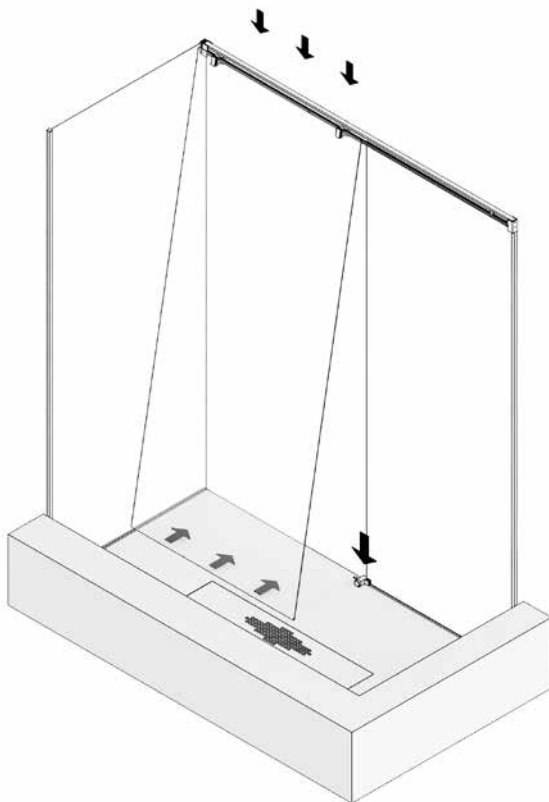

12

COLOCAMOS LAS GOMAS ALA DE CRUCE, UNA EN EL FIJO Y OTRA EN LA HOJA CORREDERA. COLOCAR EL ASA TIRADOR.



13

COLOCAR EL CIERRE GOMA IMAN FRONTAL EN EL CANTO EXTERIOR DE LA HOJA CORREDERA Y EL IMAN ADHESIVO SOBRE ESTE, RETIRANDO EL PRECINTO Y APROXIMANDO AL LATERAL FIJO PARA SU ADHESION.

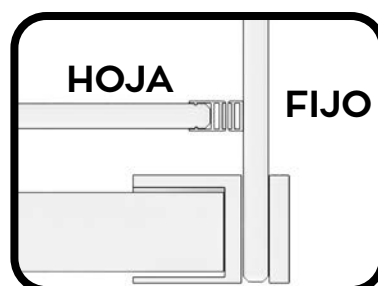
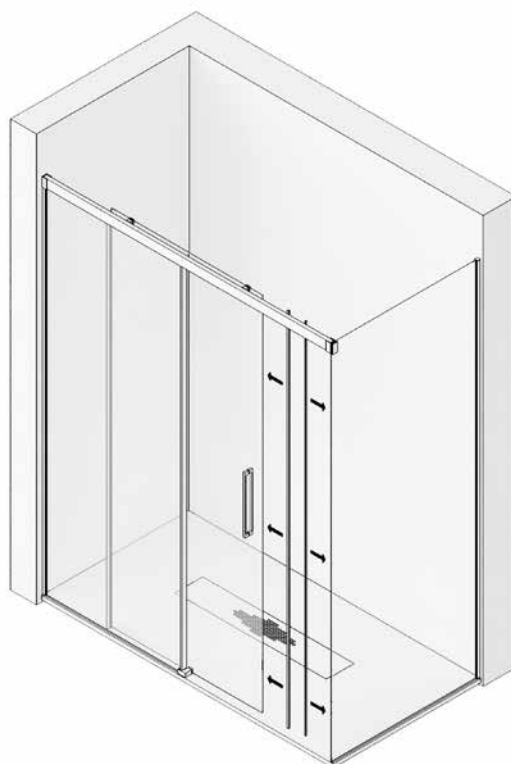

14

FIJAR LOS TOPES
FRENO EN SU POSICIÓN,
MEDIANTE SU TORNILLO
PRISIONERO.

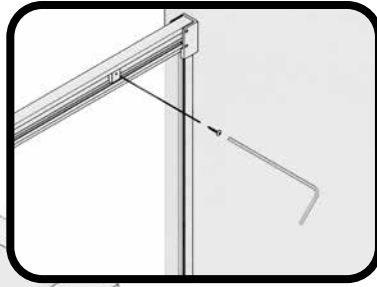

15

MEDIMOS, CORTAMOS, MONTAMOS SUS
TAPONES Y PEGAMOS EL PERFIL DE
ESTANQUEIDAD, DE PINZA INFERIOR A
LATERAL FIJO, POR DELANTE DE LA HOJA
CORREDERA.

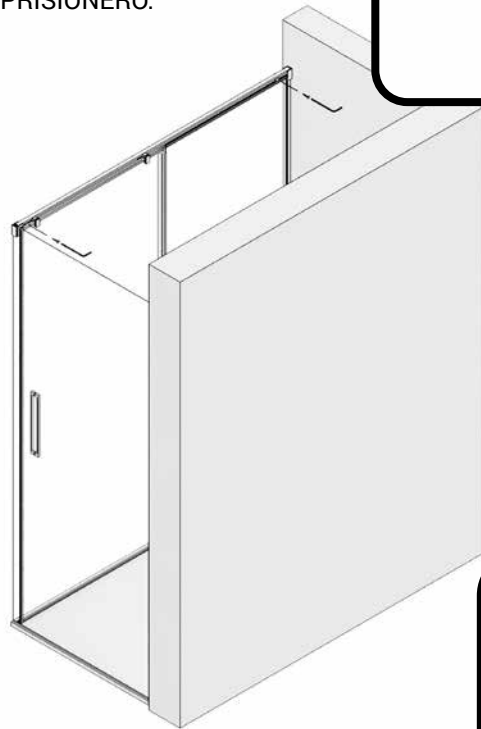

PERFIL DE ESTANQUEIDAD

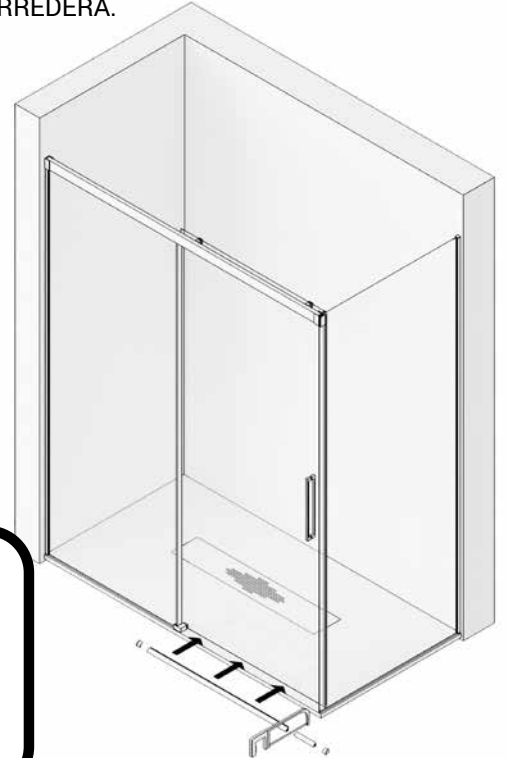
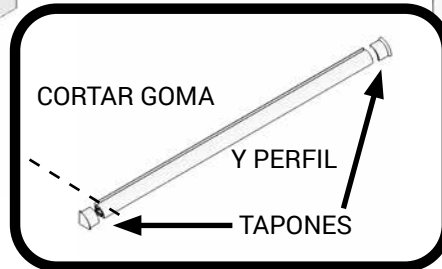





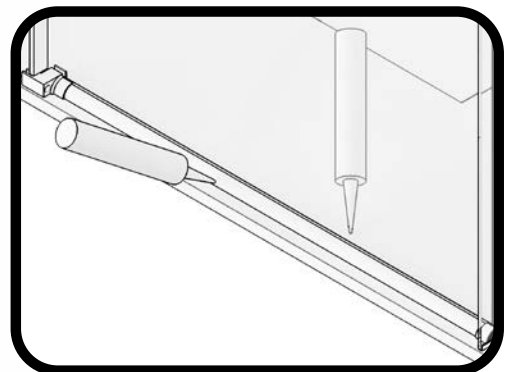



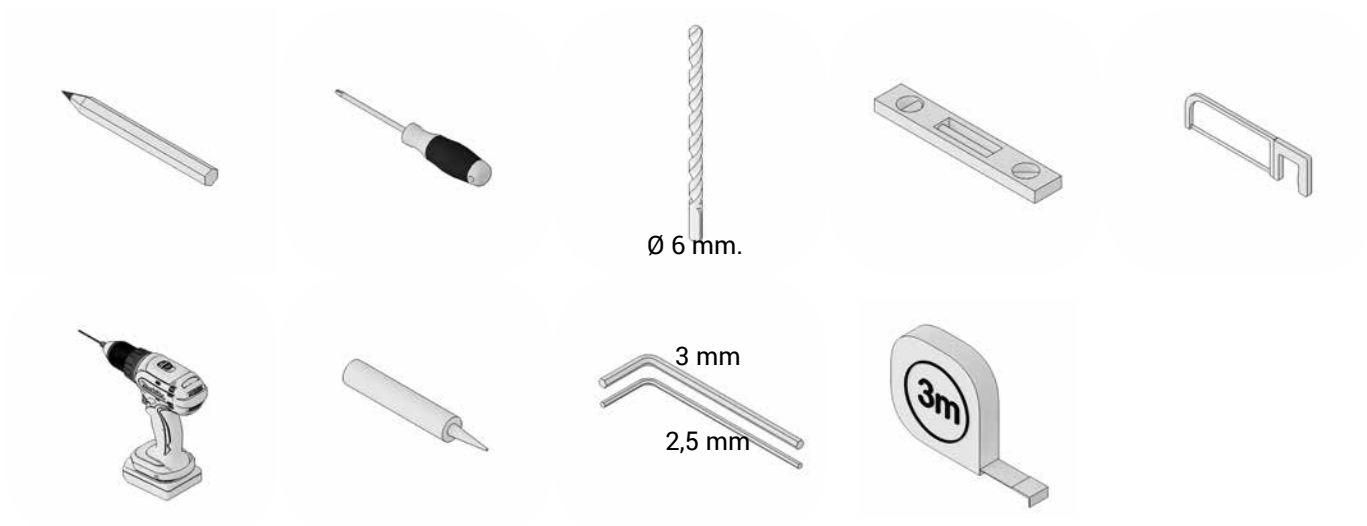







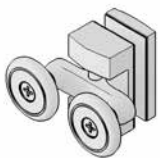

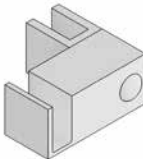



16

SELLAR CON SILICONA EL CONTORNO
EXTERIOR DE LA MAMPARA.



A3F8



- | | | | | |
|---|---|---|--|--|
| 2X

HOJA FIJA | 1X

HOJA CORREDERA | 1X

GUÍA SUPERIOR | 1X

TERMINAL A FIJO PERFIL ESTANQUEIDAD | 1X

VASO O SOPORTE GUÍA |
| 2X

RODAMIENTO SUPERIOR DOBLE TAMDEN | 2X

TOPE FRENO | 1X

PINZA GUÍA INFERIOR | 1X

ASA TIRADOR | 2X

PERFIL "U" FIJO A PARED |
| 1X

PERFIL DE ESTANQUEIDAD | 2X

TAPON PERFIL ESTANQUEIDAD | 1X

GOMA CIERRE IMAN FRONTAL | 1X

IMAN ADHESIVO | 1X

GOMA INFERIOR VIERTEAGUAS PUERTA |
| 2X

GOMAS DE ALA CRUCE FIJO/CORREDERA | 1X

GOMA ESTANQUEIDAD INFERIOR FIJO | 3X

GOMA FIJO "U" Y GUÍA SUPERIOR | 8X

TACOS N° 6 | 8X

TORNILLOS 4.2 X 32 |
| | | | | 2X

TORNILLOS AUTORROS-CANTE 3.5 X 9.5 |

fabricación nacional