

MANUAL DE MONTAJE

F2



MAMPARA FRONTAL DE DUCHA

1 HOJA CORREDERA + 1 FIJA

F2

1

PRESENTAMOS PERFIL "U" DE FIJO, EN PARED, SEGÚN CORRESPONDA SU POSICIÓN, NIVELÁNDOLO, A 3 MM. DEL BORDE DEL PLATO DE DUCHA Y MARCAMOS TALADROS.

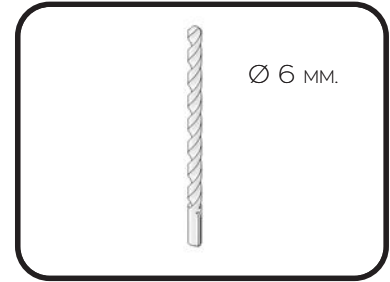
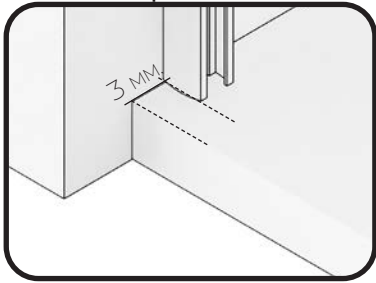
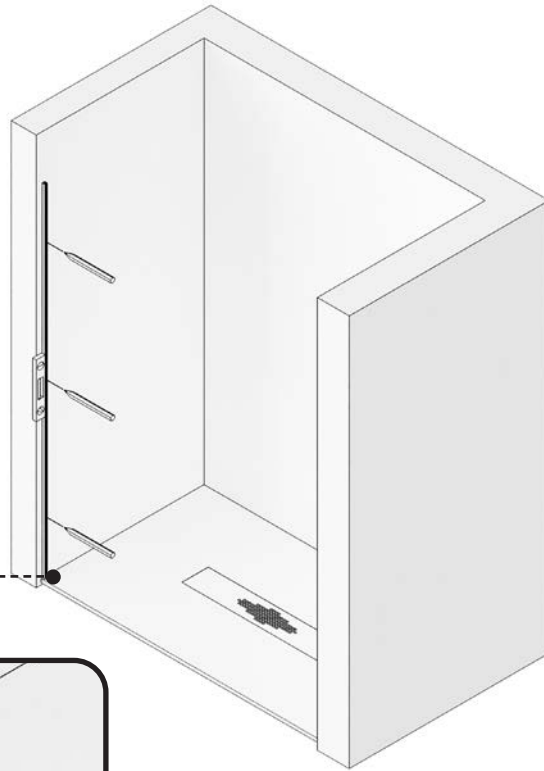

2

TALADRAR LA PARED CON BROCA Ø 6 MM.

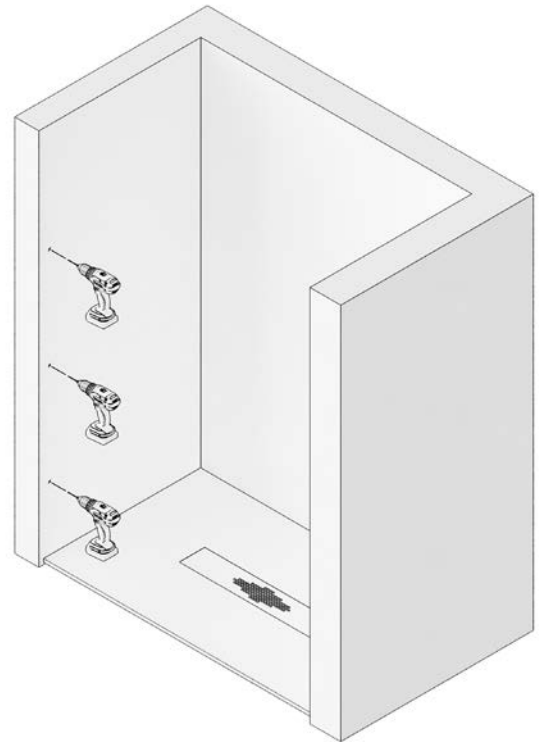

3

ATORNILLAR EL PERFIL "U" A PARED, FIJÁNDOLO CON TACOS DEL N° 6 Y LOS 3 TORNILLOS 4.2X32

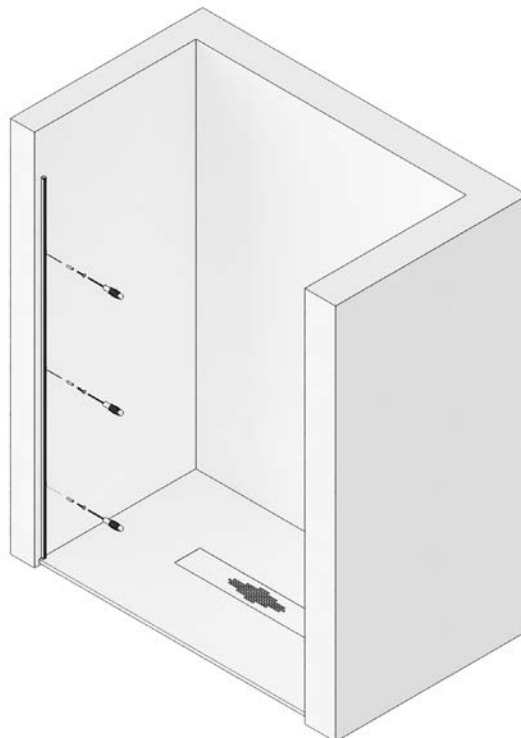

4

COLOCAMOS GOMA DE ESTANQUEIDAD INFERIOR EN LA HOJA FIJA E INTRODUCIMOS EL VIDRIO EN LA "U", APOYÁNDOLO SOBRE ESTA

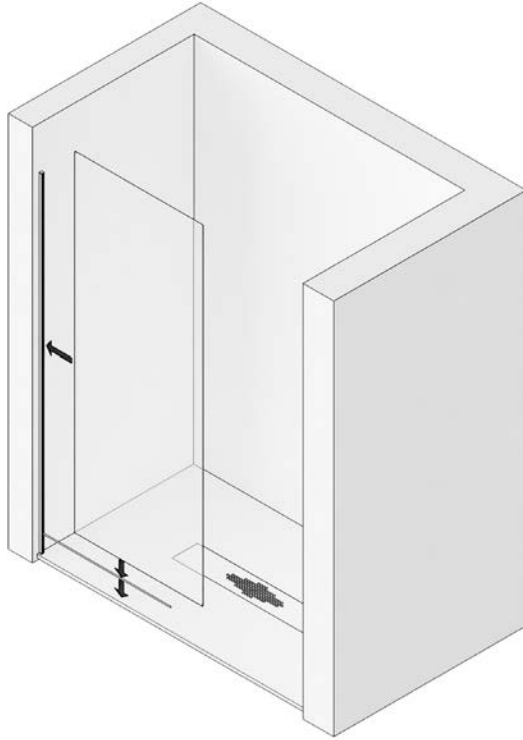

5

COLOCAR LA PINZA GUIA INFERIOR EN EL EXTREMO DEL VIDRIO FIJO, MONTÁNDOLA PREVIAMENTE SEGÚN CORRESPONDA SU POSICIÓN.

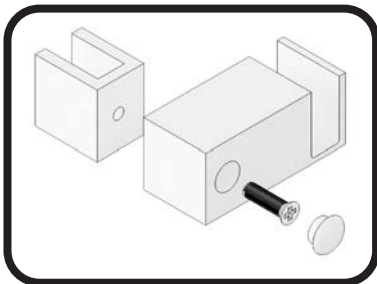
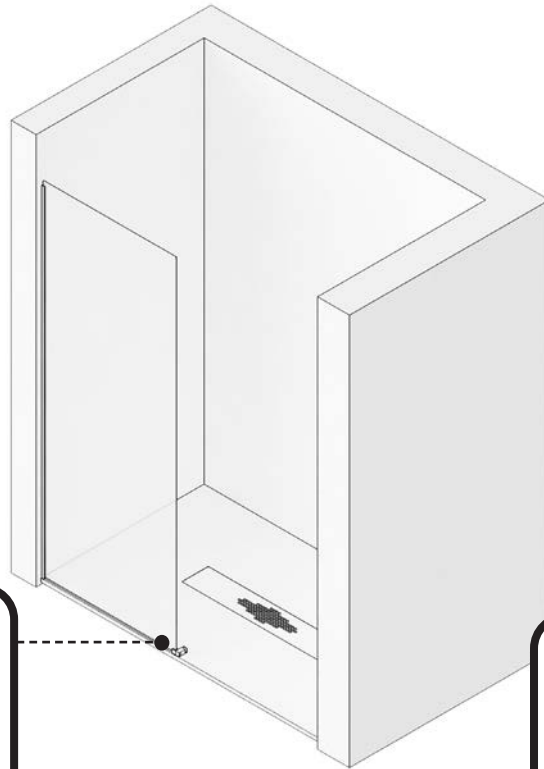

MONTAJE PINZA GUIA INFERIOR

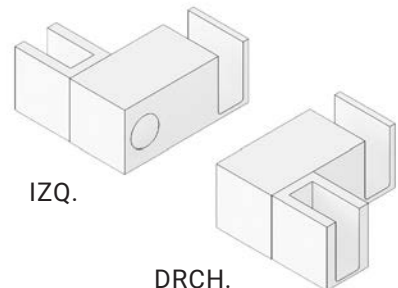

F2

6

PRESENTAR GUÍA SUPERIOR CON VASOS SOBRE EL VIDRIO FIJO, NIVELAR Y MARCAR LOS TALADROS.

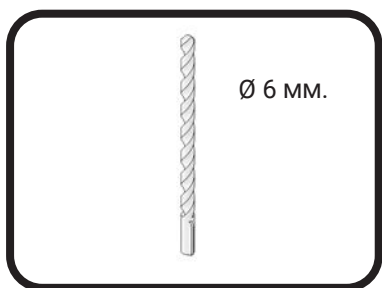
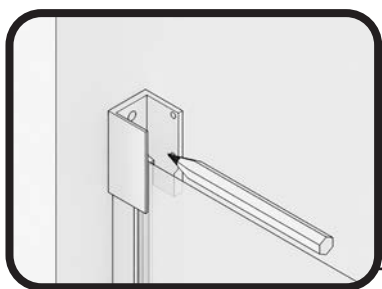

7

TALADRAR CON BROCA DE Ø 6 MM.

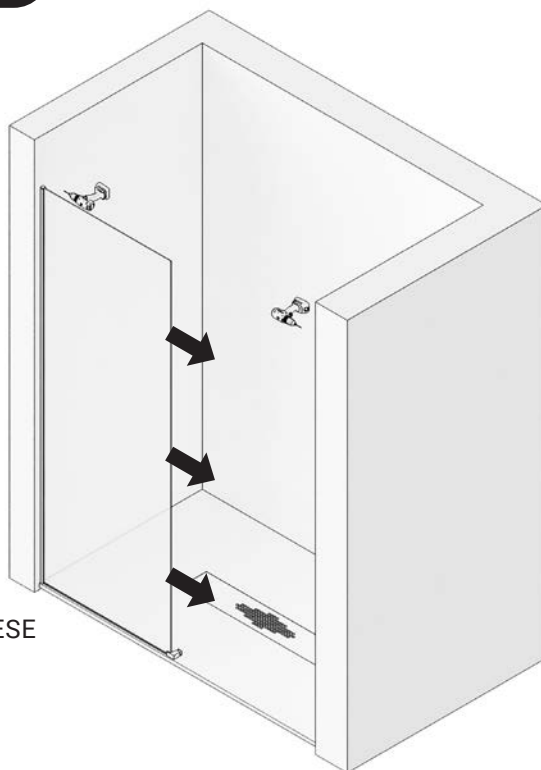

RETIRAR CRISTAL FIJO SI FUESE NECESARIO.

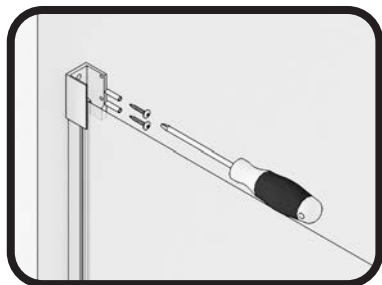

8

ATORNILLAR LOS VASOS SOPORTE GUÍA SUPERIOR A PARED.



9

INTRODUCIR EL TOPE FRENO EN GUIA SUPERIOR, DESPLAZANDOLO HACIA EL FINAL DE LA HOJA FIJA, COLOCAR LA GUIA SUPERIOR EN LOS VASOS COGIDA A PARED Y FIJAR LA COGIDA A LA GUIA MEDIANTE LOS TORNILLOS PRISIONEROS CON LLAVE HALLEN. ENGOMAR CRISTAL FIJO A PERFIL PARED Y A GUÍA SUPERIOR.

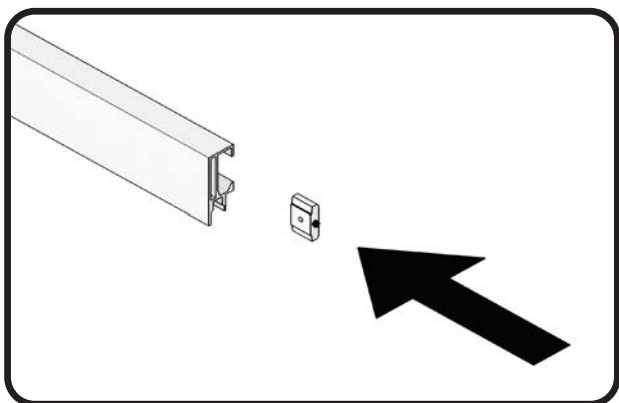

10

MONTAR CONJUNTO RUEDAS, GRADUADAS EN SU ALTURA MÁXIMA Y GOMA INFERIOR VIERTEAGUAS EN HOJA CORREDERA.

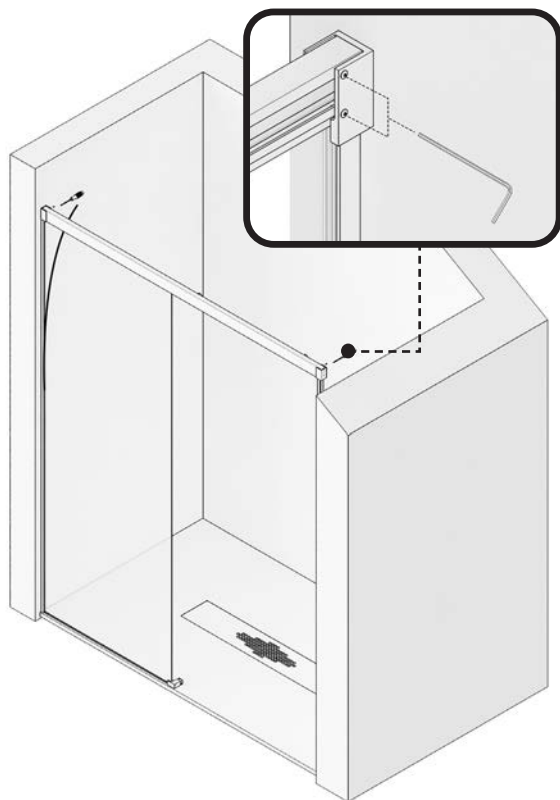

ALTURA MÁXIMA

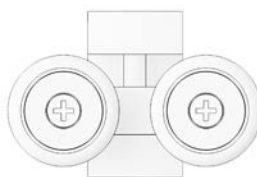

ALTURA MÍNIMA

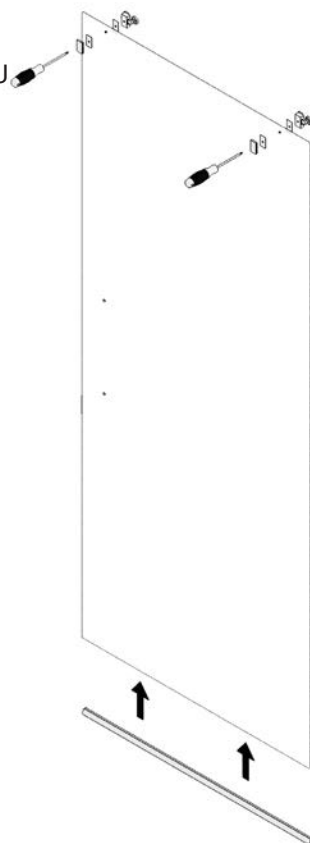
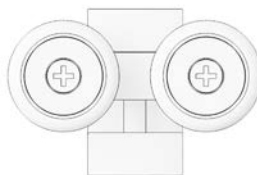

11

COLGAR LA HOJA CORREDERA EN LA GUIA SUPERIOR, INTRODUCIENDO EL CONJUNTO RUEDAS EN LA MISMA Y EN LA PINZA GUIA INFERIOR, GRADUANDO EN ALTURA Y NIVELANDO LA HOJA CORREDERA, HACIENDO DESCENDER LA HOJA MEDIANTE LOS TORNILLOS DE REGULACION DE RUEDAS, CON UN DESTORNILLADOR.

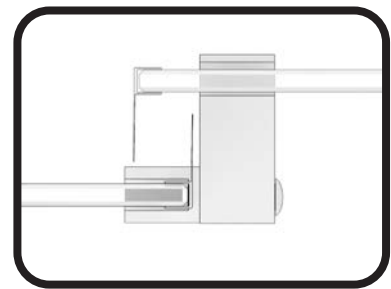
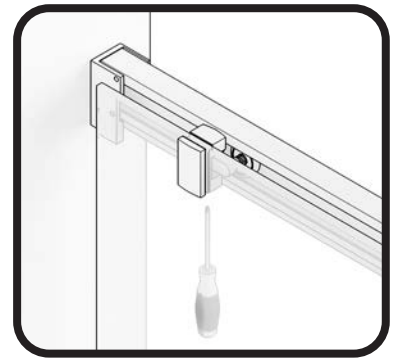
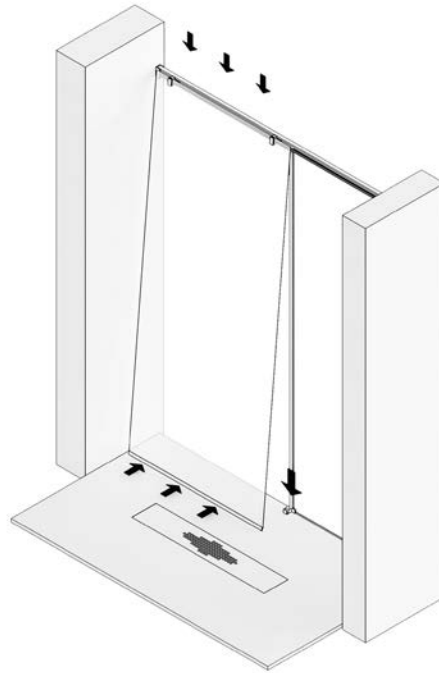

12

COLOCAMOS LAS GOMAS ALA DE CRUCE, UNA EN EL FIJO Y OTRA EN LA HOJA CORREDERA. COLOCAR EL ASA TIRADOR.

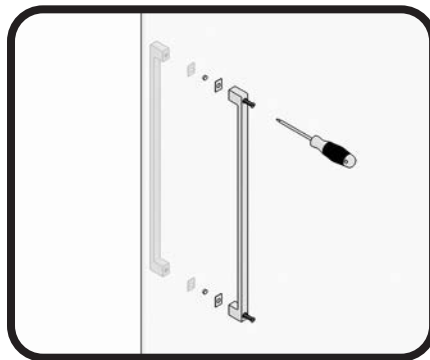

13

COLOCAR EL CIERRE GOMA IMAN FRONTAL EN EL CANTO EXTERIOR DE LA HOJA CORREDERA Y PRESENTAR SOBRE ESTE EL PERFIL CIERRE IMAN. APROXIMAR LA HOJA CORREDERA AL CIERRE EN PARED, MARCAMOS SU POSICIÓN, NIVELANDOLO Y ATORNILLANDOLO, RETIRANDO EL IMÁN PARA SU COLOCACIÓN.

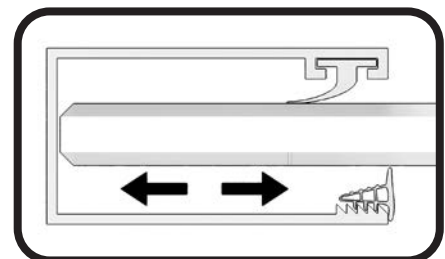

AJUSTAR EL JUEGO DEL VIDRIO FIJOS SEGÚN NECESIDAD. FIJAR EL VIDRIO, ENGOMANDO EL CRISTAL CON EL PERFIL A PARED Y CON LA GUIA SUPERIOR.

14

FIJAR EL TOPE FRENO EN SU POSICIÓN, MEDIANTE SU TORNILLO PRISIONERO.

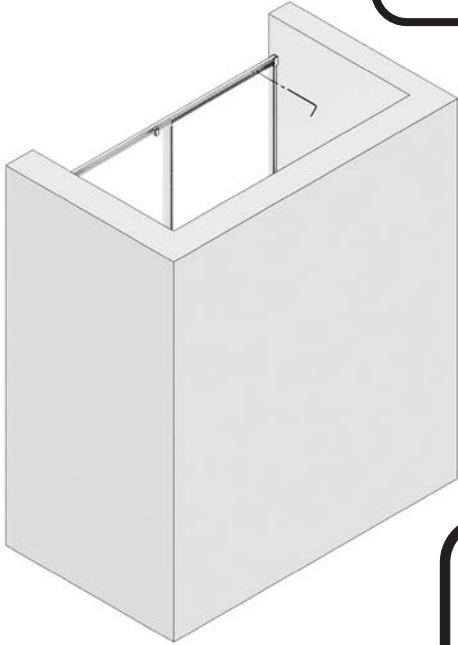
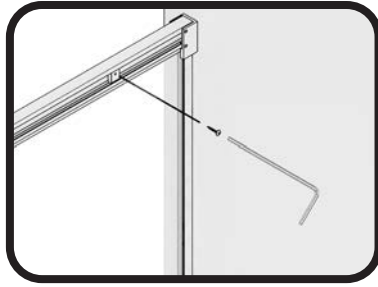

15

MEDIMOS, CORTAMOS, MONTAMOS SUS TAPONES Y PEGAMOS EL PERFIL DE ESTANQUEIDAD, DE PINZA INFERIOR A PARED POR DELANTE DE LA HOJA CORREDERA.



PERFIL DE ESTANQUEIDAD

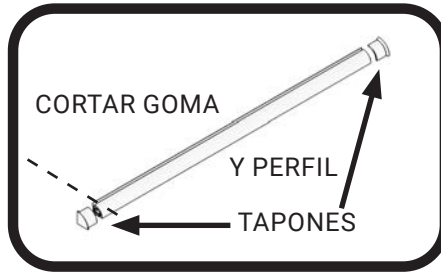





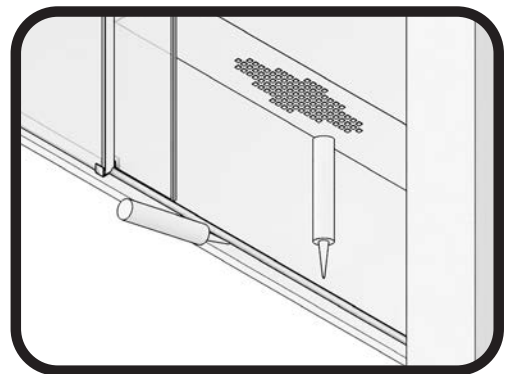



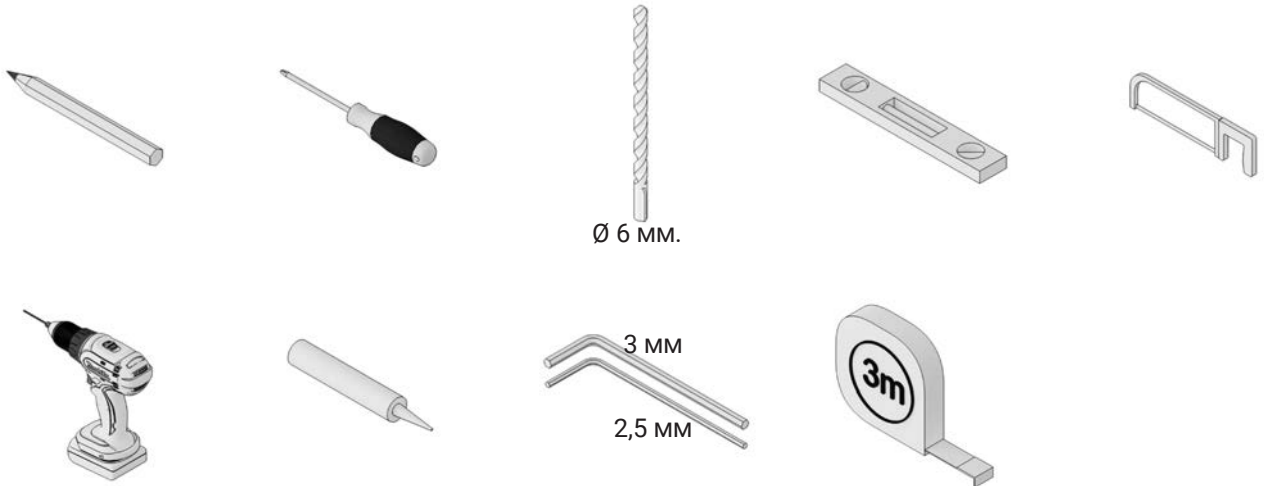





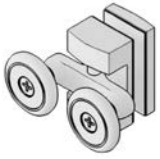
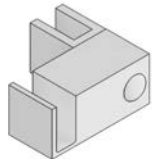





16

SELLAR CON SILICONA EL CONTORNO EXTERIOR DE LA MAMPARA.



F2



- | | | | | | |
|--|--|---|--|---|--|
| 1X

HOJA FIJA | 1X

HOJA CORREDERA | 2X

VASO O SOPORTE GUÍA | 1X

TAPA EMBELLECEDORA VASO
SOPORTE GUÍA | 2X

RODAMIENTO SUP DOBLE
TÁMRFN | |
| 1X

GUÍA PINZA INFERIOR | 1X

TOPE FRENO | 1X

ASA TIRADOR | 10X

TACOS N° 6 | 10X

TORNILLO 4,2 X 32 | |
| 1X

TAPA PERFIL CIERRE IMÁN A
PARED | 2X

TERMINAL PERFIL VIERTEA-
GUAS | 1X

PERFIL "U" FIJO A PARED | 1X

CIERRE IMÁN A PRED | 1X

PERFIL GUÍA SUPEROR | |
| 1X

PERFIL DE ESTANQUEI-
DAD | 2X

GOMAS DE ALA CRUCE
FIJO/CORREDERA | 1X

CIERRE IMÁN HOJA | 1X

GOMA ESTANQUEIDAD
INFERIOR FIJO | 1X

GOMA INFERIOR
VIERTEAQUAS PUERTA | 2X

GOMA FIJO "U"
Y GUIA SUPERIOR |