

# MANUAL DE MONTAJE

## A3



### **MAMPARA ANGULAR DE DUCHA**

1 HOJA CORREDERA + 2 FIJAS

A3

**1**

PRESENTAMOS PERFILES "U" DE FIJOS, EN PAREDES, SEGÚN CORRESPONDA SU POSICIÓN, NIVELÁNDOLO, A 3 MM. DEL BORDE DEL PLATO DE DUCHA Y MARCAMOS TALADROS.

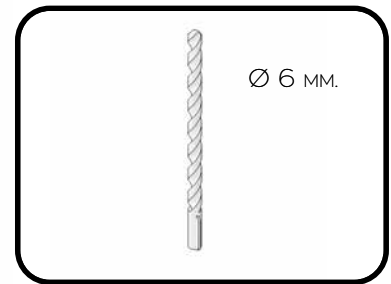
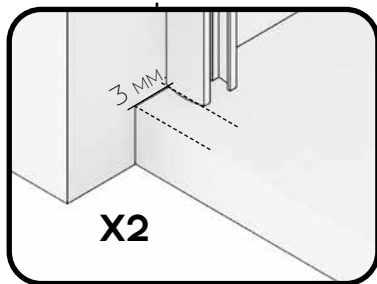

**2**

TALADRAR LA PARED CON BROCA DE 6MM.

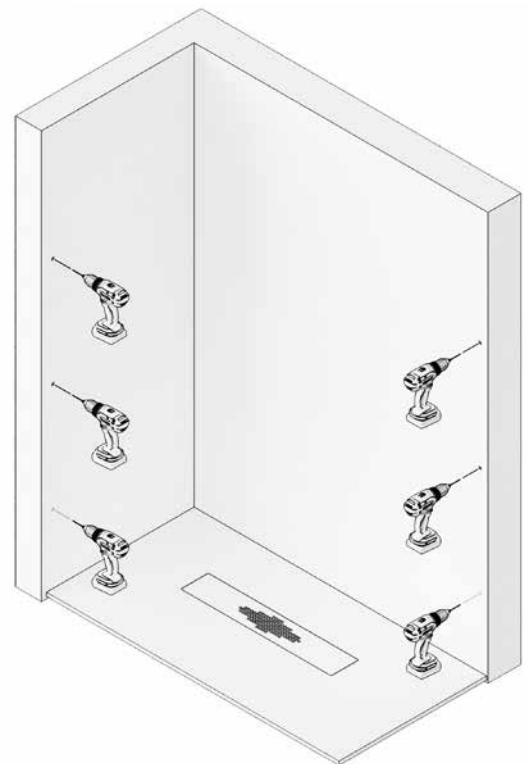

**3**

ATORNILLAR LOS PERFILES "U" A PARED, FIJÁNDOLOS CON TACOS DEL N° 6 Y LOS 6 TORNILLOS 4.2X32.

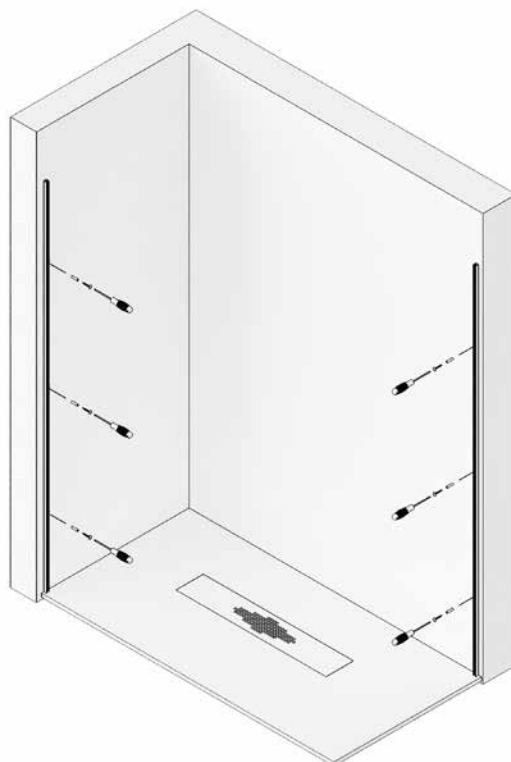

# 4

COLOCAMOS GOMA DE ESTANQUEIDAD INFERIOR EN LAS HOJAS FIJAS E INTRODUCIMOS LOS VIDRIOS EN LAS "U", APOYANDOLOS SOBRE ESTA.

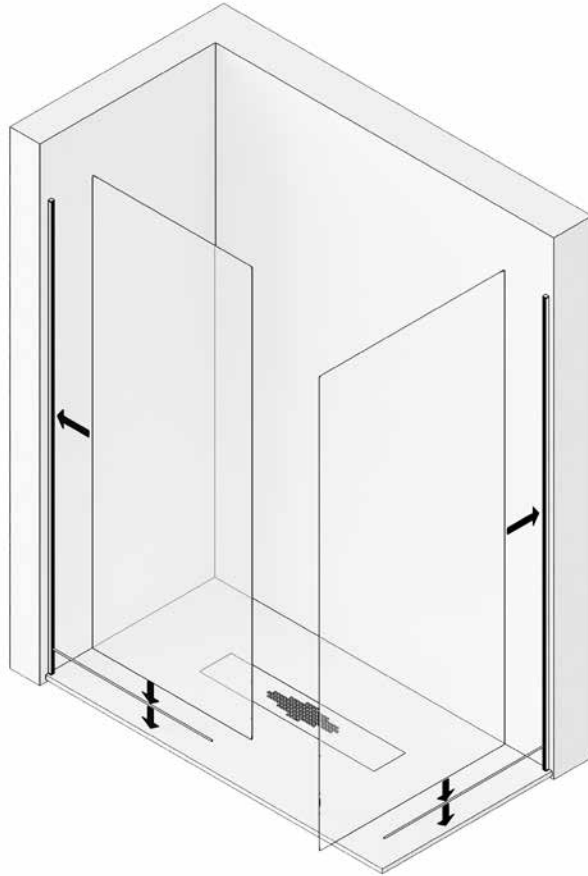

# 5

COLOCAR LA PINZA GUIA INFERIOR EN EL EXTREMO DEL VIDRIO FIJO FRONTAL, MONTANDOLA PREVIAMENTE SEGÚN CORRESPONDA SU POSICIÓN.

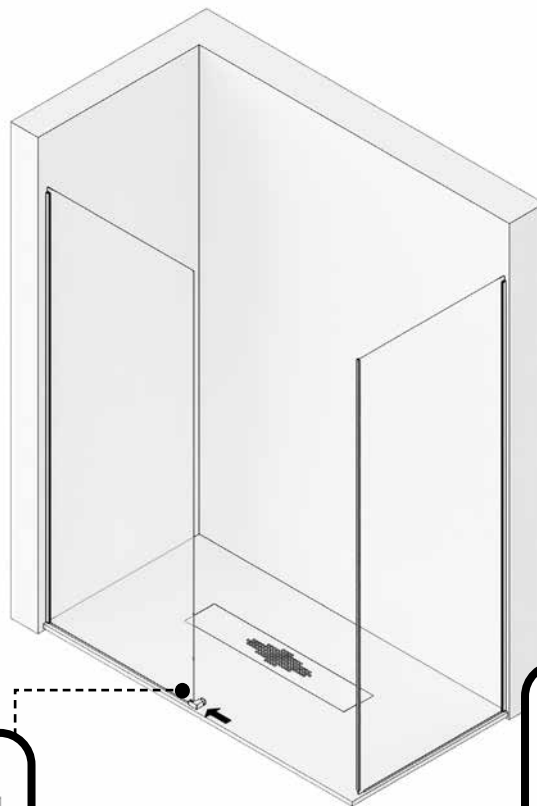

## MONTAJE PINZA GUIA INFERIOR

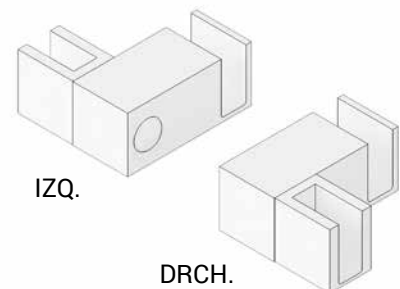
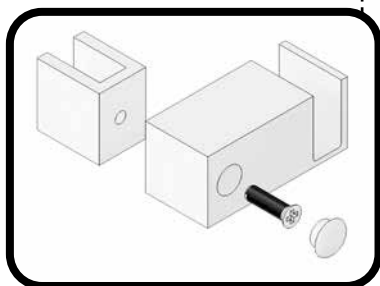

**6**

PRESENTAR GUÍA SUPERIOR CON VASOS Y CODO UNIÓN, FIJÁNDOLO CON SUS TORNILLOS AUTOROSCANTES, SOBRE LOS VIDRIOS FIJOS, NIVELAR Y MARCAR LOS TALADROS.

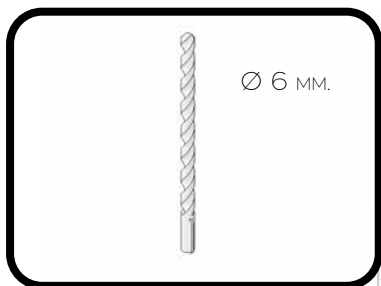
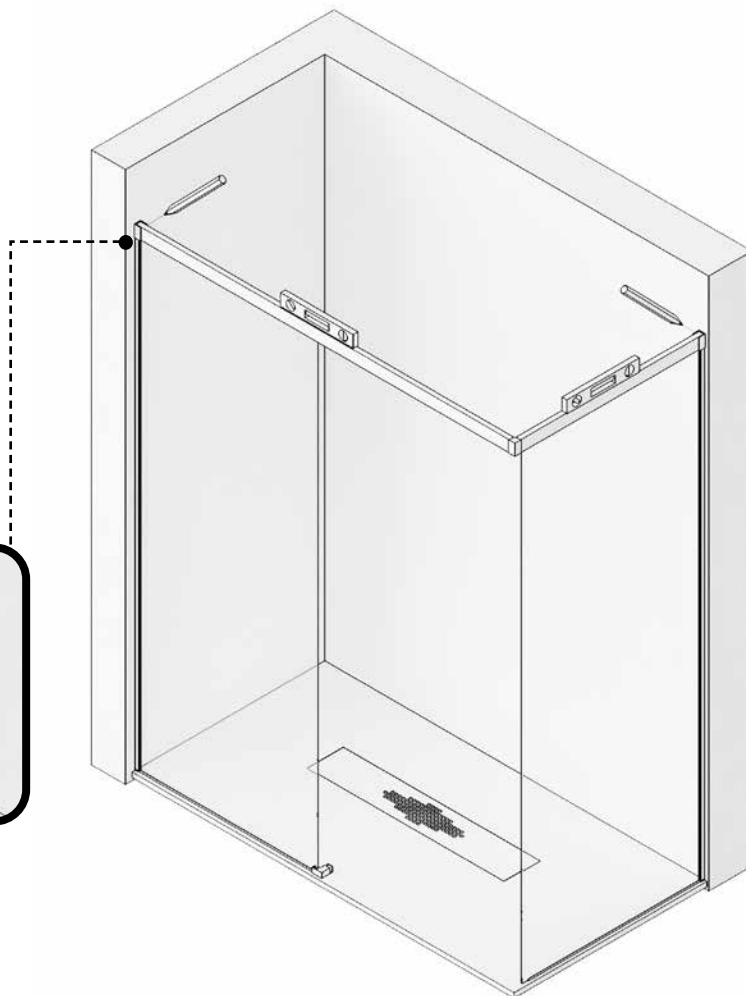
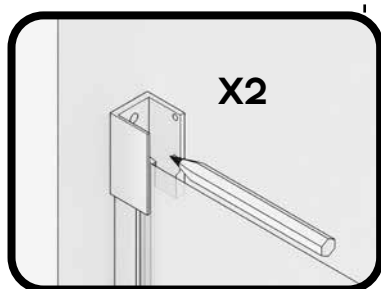
**7**

TALADRAR LA PARED CON BROCA DE 6MM.



RETIRAR CRISTALES FIJOS SI FUESE NECESARIO.

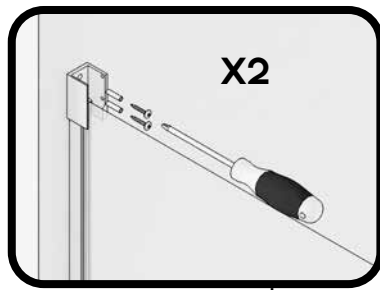

**8**

ATORNILLAR LOS VASOS SOPORTE GUÍA SUPERIOR A PARED.

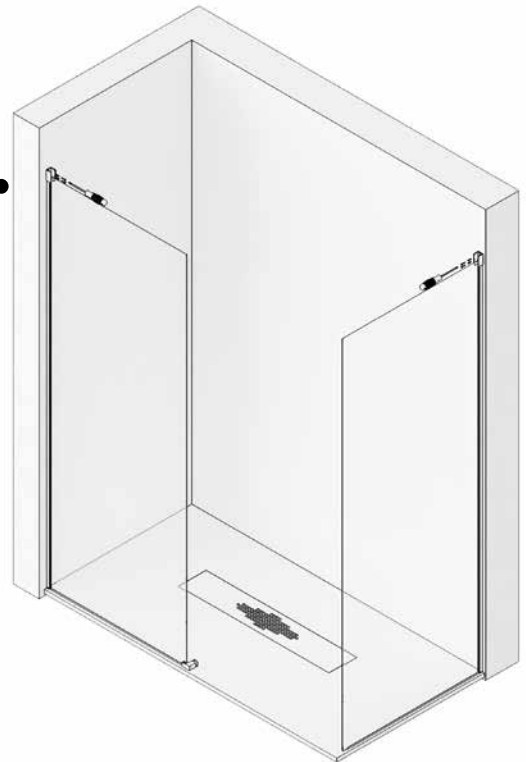

**9**

INTRODUCIR LOS 2 TOPES FRENO EN LA GUÍA SUPERIOR FRONTAL, DESPLAZÁNDOLO UNO HACIA EL FINAL DE LA HOJA FIJA Y OTRO AL VÉRTICE, COLOCAR LA GUÍA SUPERIOR UNIDA, EN LOS VASOS COGIDA A PARED Y FIJAR LA COGIDA A LA GUÍA MEDIANTE LOS TORNILLOS PRISIONEROS CON LLAVE HALLEN. ENGOMAR CRISTAL FIJO A PERFIL PARED Y A GUÍA SUPERIOR.

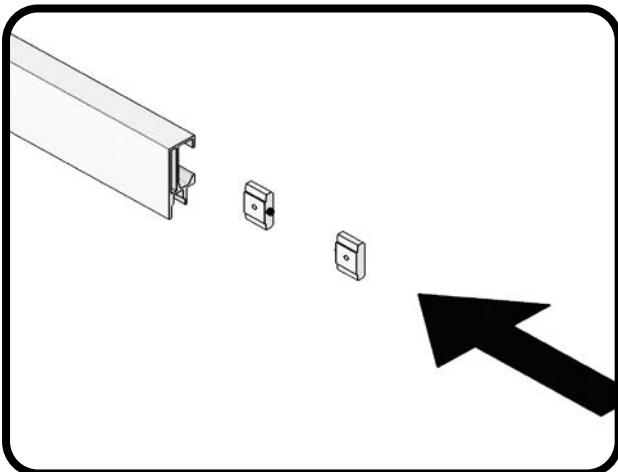

**10**

MONTAR CONJUNTO RUEDAS, GRADUADAS EN SU ALTURA MÁXIMA Y GOMA INFERIOR VIERTEGUAS EN LA HOJA CORREDERA.

ALTURA MÁXIMA

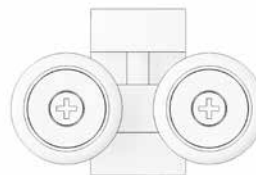

ALTURA MÍNIMA

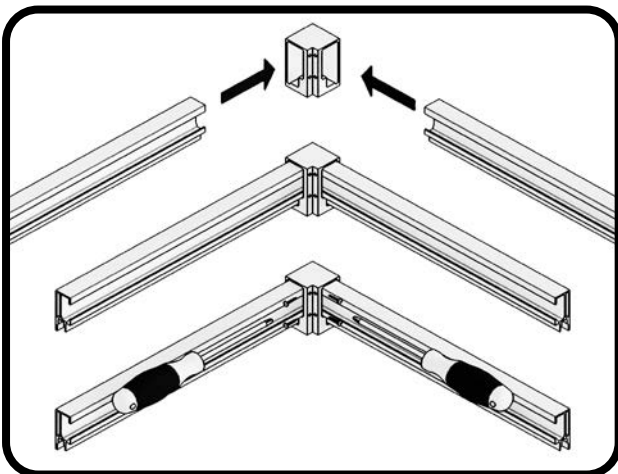
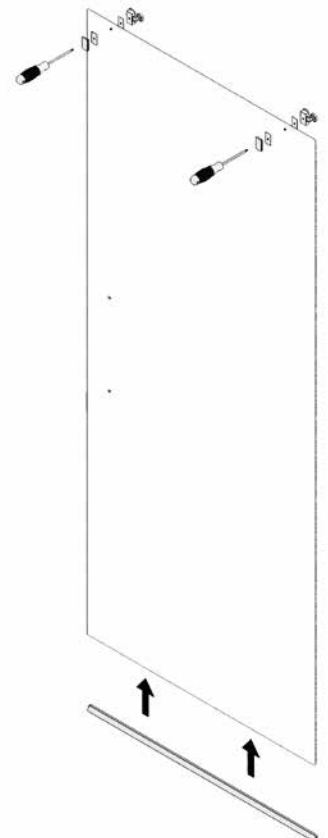
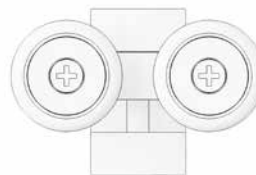

A3

# 11

COLGAR LA HOJA CORREDERA EN LA GUIA SUPERIOR, INTRODUCIENDO EL CONJUNTO RUEDAS EN LA MISMA Y EN LA PINZA GUIA INFERIOR, GRADUANDO EN ALTURA Y NIVELANDO LA HOJA CORREDERA AL CIERRE CON EL LATERAL FIJO, HACIENDO DESCENDER LA HOJA MEDIANTE LOS TORNILLOS DE REGULACION DE RUEDAS, CON UN DESTORNILLADOR.

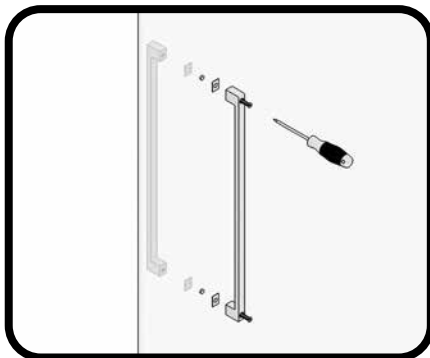
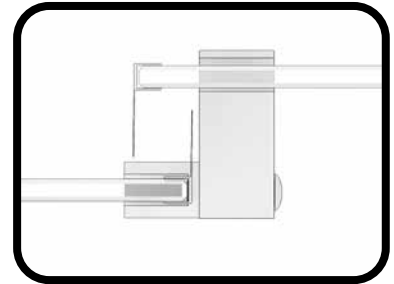
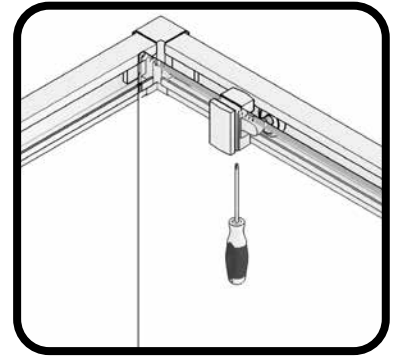
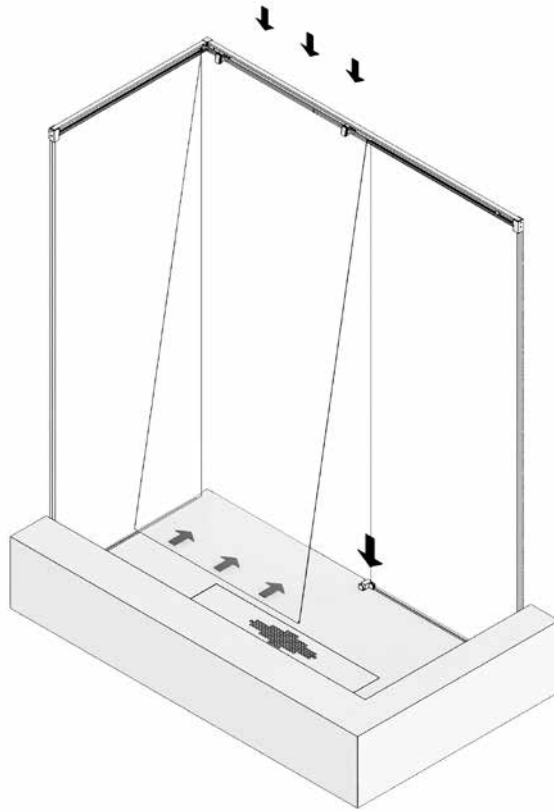

# 12

COLOCAMOS LAS GOMAS ALA DE CRUCE, UNA EN EL FIJO Y OTRA EN LA HOJA CORREDERA. COLOCAR EL ASA TIRADOR.



# 13

COLOCAR LOS CIERRE GOMA IMAN EN LOS CANTOS EXTERIORES DE LA HOJA CORREDERA Y LATERAL FIJO.

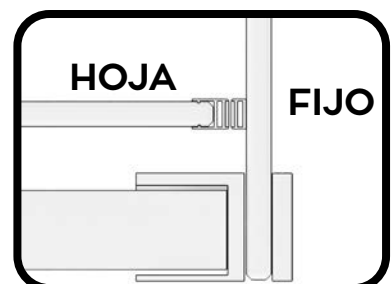

# 14

FIJAR LOS TOPE FRENO EN SU POSICIÓN, MEDIANTE SU TORNILLO PRISIONERO.

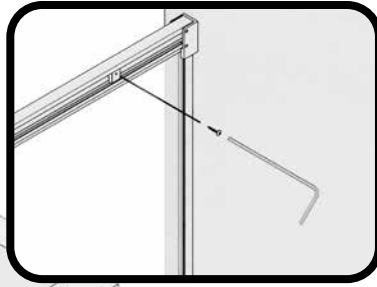

# 15

MEDIMOS, CORTAMOS, MONTAMOS SUS TAPONES Y PEGAMOS EL PERFIL DE ESTANQUEIDAD, DE PINZA INFERIOR AL CODO DEL VERTICE, POR DELANTE DE LA HOJA CORREDERA Y DE ESTE A PARED.

PERFIL DE ESTANQUEIDAD

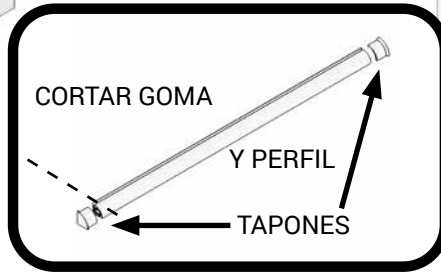





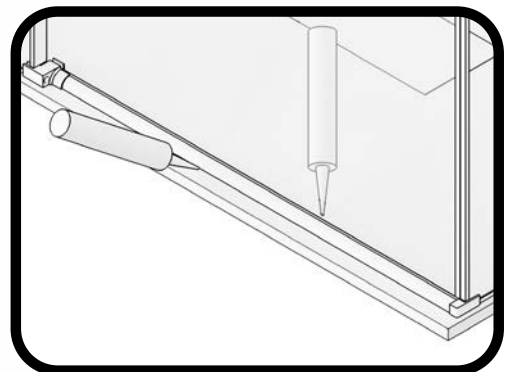



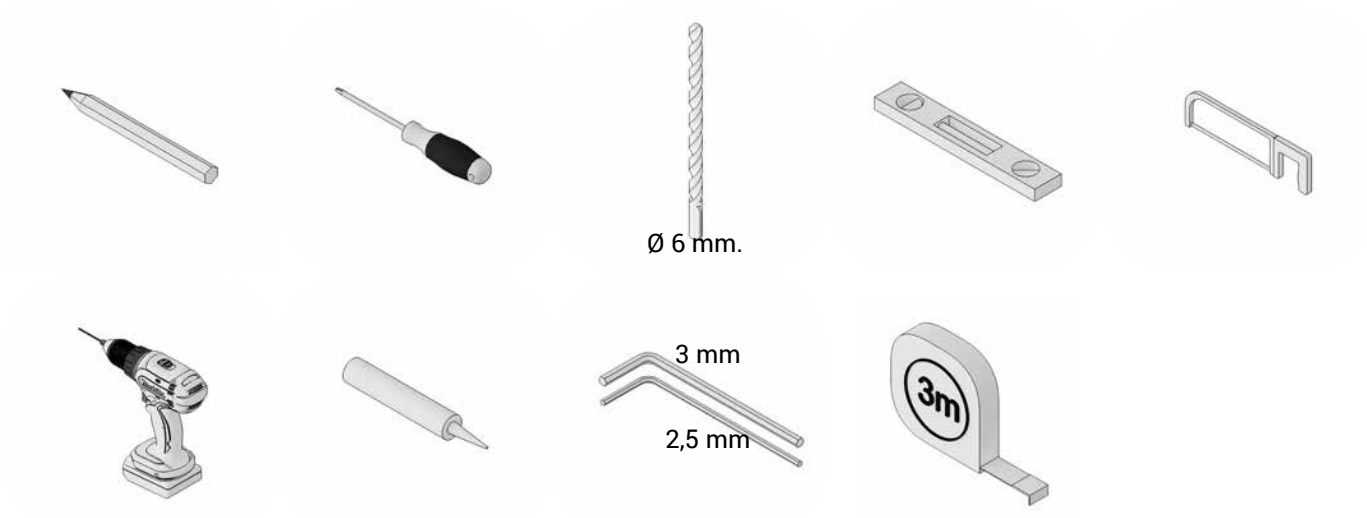







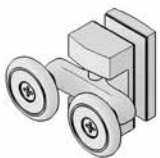

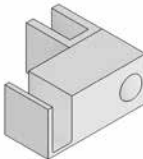

# 16

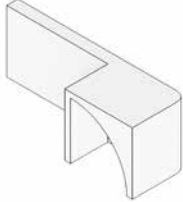
SELLAR CON SILICONA EL CONTORNO EXTERIOR DE LA MAMPARA.

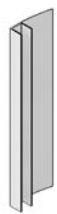

# A3



- |  |  |   |  |   |  |
|--|--|---|--|---|--|
| <b>2X</b><br><br>HOJA FIJA                          | <b>1X</b><br><br>HOJA CORREDERA               | <b>2X</b><br><br>GUÍA SUPERIOR                         | <b>1X</b><br><br>CODO UNIÓN GUÍA              | <b>2X</b><br><br>VASO O SOPORTE GUÍA               |  |
| <b>2X</b><br><br>RODAMIENTO SUPERIOR DOBLE TAMDEN | <b>2X</b><br><br>TOPE FRENO                 | <b>1X</b><br><br>GUÍA PINZA INFERIOR                 | <b>1X</b><br><br>ASA TIRADOR                | <b>2X</b><br><br>PERFIL "U" FIJO A PARED         |  |
| <b>1X</b><br><br>PERFIL DE ESTANQUEIDAD           | <b>1X</b><br><br>TERMINAL PERFIL VERTEAGUAS | <b>1X</b><br><br>TERMINAL A FIJO PERFIL ESTANQUEIDAD | <b>1X</b><br><br>CIERRE IMAN FRONTO-LATERAL | <b>1X</b><br><br>GOMA INFERIOR VERTEAGUAS PUERTA |  |
| <b>1X</b><br><br>GOMA ESTANQUEIDAD INFERIOR FIJO  | <b>2X</b><br><br>GOMAS DE ALA CRUCE         | <b>3X</b><br><br>GOMA CUÑA FIJACION VIDRIO           | <b>10X</b><br><br>TACOS Nº 6                  | <b>10X</b><br><br>TORNILLOS 4.2 X 32             | <b>2X</b><br><br>TORNILLOS AUTORROS-CANTE 3.5 X 9.5 |

fabricación nacional